

# Assembly Instructions

MFR# 9S216-500-4

Leather Ottoman

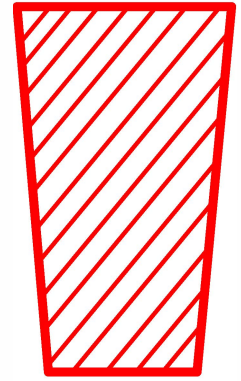
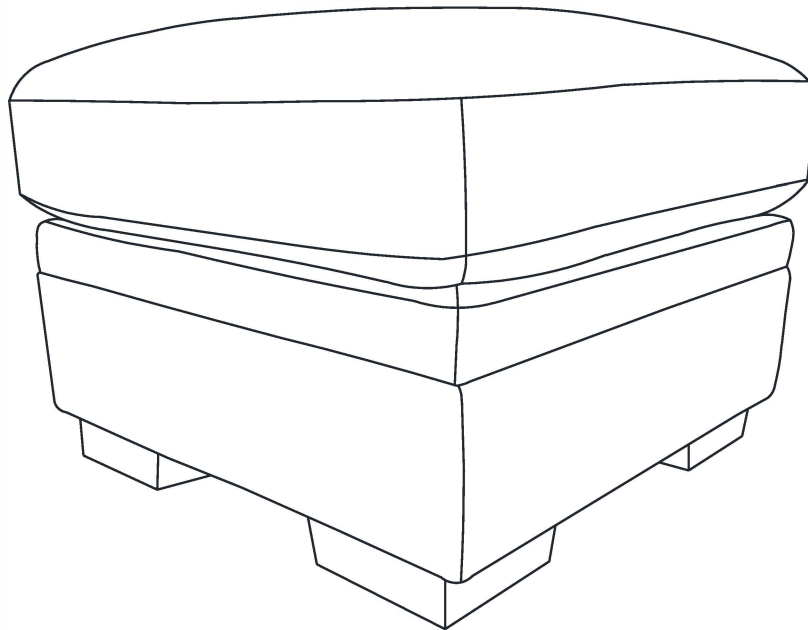

**IMPORTANT, RETAIN FOR FUTURE REFERENCE: READ CAREFULLY**  
For more information, visit: [www.northridge-home.com](http://www.northridge-home.com)

For parts or customer service call: **1-866-387-8065**

Or email: [info@northridge-home.com](mailto:info@northridge-home.com)

(English, French and Spanish languages spoken)

Monday-Friday 8am - 8pm (EST).

Telephone number is only valid in the United States and Canada.

**WARNING:** Small parts choking hazard

## Care & Cleaning

- Avoid exposing furniture directly to sunlight or heating and air conditioning outlets.
- Exposure to sunlight or heating and air conditioning outlets will fade/damage leather.
  - Wipe gently with a damp soft cloth to remove dust, dirt and any buildup.
  - Wipe the leather with a professional cleanser.

A x 1

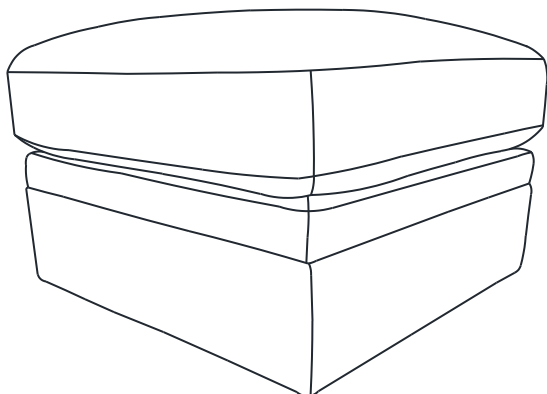

B x 4

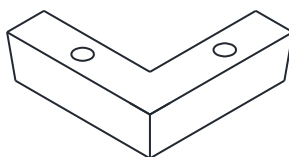

C x 8

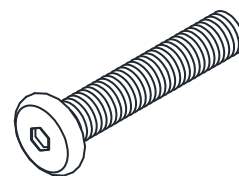

D x 8



E x 8



F x 1

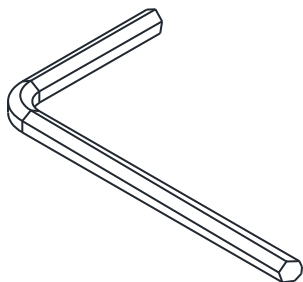

Touch-up Pen



1

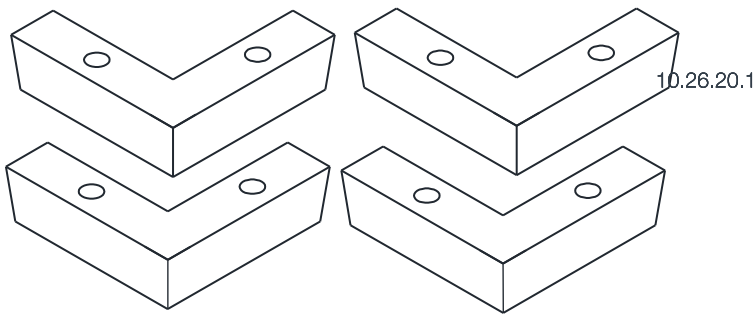
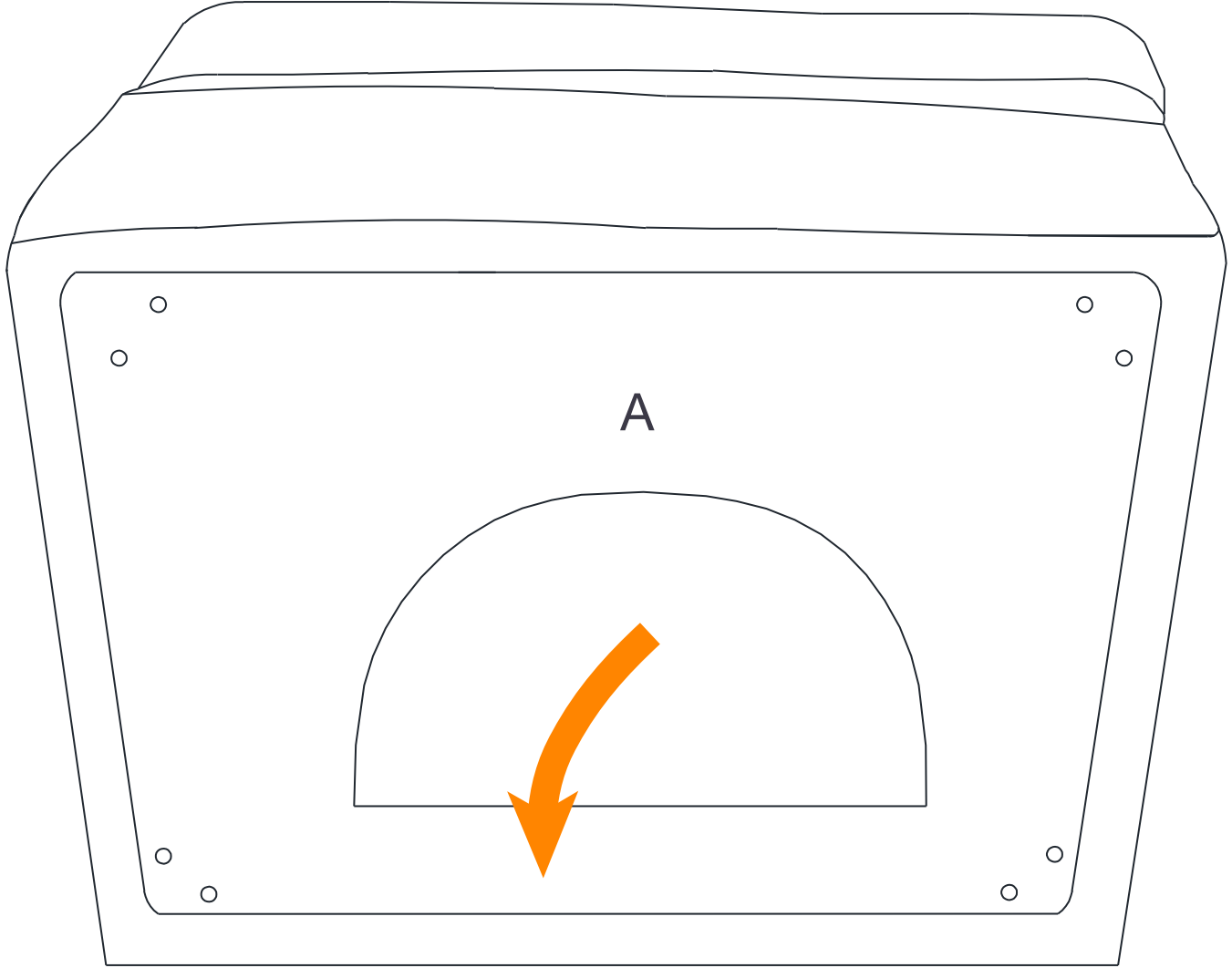

2

